

USER'S MANUAL

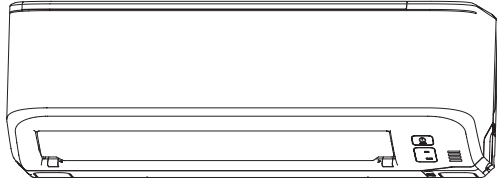

AIR-CONDITIONER

ENGLISH



DXK09Z5L-S
DXK12Z5L-S
DXK15Z5L-S

MANUAL DEL PROPIETARIO

ACONDICIONADOR DE AIRE

ESPAÑOL

MANUAL DO UTILIZADOR

APARELHO DE AR CONDICIONADO

PORTUGUÊS

KULLANIM KILAVUZU

SPLIT KLİMA

TÜRKÇE



This air conditioner complies with **EMC** Directive 2004/108/EC,
LV Directive 2006/95/EC.

Este acondicionador de aire cumple con la directiva **EMC**: 2004/
108/EC, LV Directiva 2006/95/EC.

Este aparelho de ar condicionado está em conformidade com a
Directiva **EMC** 2004/108/EC e a Directiva LV 2006/95/EC.

Thank you for purchasing a MITSUBISHI HEAVY INDUSTRIES, LTD. Air-Conditioner. To get the best long-lasting performance, please read and follow this User's Manual carefully before using your air-conditioner. After reading, please store the Manual in a safe place and refer to it for operational questions or in the event of any irregularities.

This air-conditioner is intended for domestic use.

Do not vent R410A into the atmosphere: R410A is a fluorinated greenhouse gas, covered by the Kyoto Protocol with a Global Warming Potential (GWP) = 1975.



Your Air Conditioning product may be marked with this symbol. It means that waste electrical and electronic equipment (WEEE as in directive 2012/19/EU) should not be mixed with general household waste. Air conditioners should be treated at an authorized treatment facility for re-use, recycling and recovery and not be disposed of in the municipal waste stream. Please contact the installer or local authority for more information.



This symbol printed in the batteries attached to your Air Conditioning product is information for end-users according to the EU directive 2013/56/EU article 20 annex II. Batteries, at their end-of-life, should be disposed of separately from general household waste. If a chemical symbol is printed beneath the symbol shown above, this chemical symbol means that the batteries contain a heavy metal at a certain concentration. This will be indicated as follows: Hg:mercury(0.0005%) , Cd:cadmium(0.002%) , Pb:lead(0.004%) Please, dispose of batteries correctly at your local community waste collection or the recycling center.



The emission sound pressure level from each Indoor and Outdoor unit is under 70 dB(A).

contents

Safety precautions	2	SLEEP TIMER operation	13
Name of each part and its function	6	OFF-TIMER operation	13
Remote control handling	8	ON-TIMER operation	14
Operation failure with the remote control	8	SLEEP TIMER + ON-TIMER operation	14
Temporary run operation	8	PROGRAM TIMER operation	15
Operation and display section for remote control	9	HIGH POWER/ECONOMY operation	16
Current time setting	9	SELF CLEAN operation	17
AUTO mode operation	10	Auto restart function	17
Temperature adjustment during AUTO	10	Tips for effective operation	17
FAN SPEED	10	Maintenance	18
COOL/HEAT/DRY/FAN mode operation	11	Proper installation	20
Air-conditioner operable temperature setting	11	Troubleshooting	20
Characteristics of HEAT mode operation ...	11	Notice	21
Airflow direction adjustment	12	Contact your dealer	22
		Self diagnosis function	23

Safety precautions

- Before starting to use the system, please read these “Safety precautions” carefully to ensure proper operation of the system.
- When you have read this instruction manual, please keep it without missing. If someone else takes over as operator, make certain that the manual is also passed on to the new operator.



 WARNING	Improper handling could lead to drastic result like death, serious injury, etc.
 CAUTION	Might pose a serious problem, depending on the circumstances.





Please observe these precautions with great care, since they are essential to your safety.

- Symbols which appear frequently in the text have the following meaning:

	Strictly prohibited		Observe instructions with great care		Provide proper earthing
-----------------------------------------------------------------------------------	----------------------------	-----------------------------------------------------------------------------------	---------------------------------------------	-----------------------------------------------------------------------------------	--------------------------------

■ INSTALLATION PRECAUTIONS

 WARNING	
	<ul style="list-style-type: none"> • The system is for domestic, residential etc. use. If used in severer environments, such as an engineering workplace, the equipment may function poorly.
	<ul style="list-style-type: none"> • The system must be installed by your dealer or a qualified professional. It is not advisable to install the system by yourself, as faulty handling may cause leakage of water, electric shock or fire.

 CAUTION	
	<ul style="list-style-type: none"> • Do not install it where flammable gas may leak. Gas leaks may cause fire.
	<ul style="list-style-type: none"> • Depending on the place of installation, an earth leakage breaker may be necessary. If you do not install an earth leakage breaker, you may get an electric shock. • Make sure to install the drain hose properly so that all the water is drained out. Improper installation may lead to water drop in the room resulting in wet furniture.
	<ul style="list-style-type: none"> • Make sure that the system has been properly earthed. Earth cables should never be connected to a gas pipe, water pipe, lightning conductor or telephone earth cable. Incorrect installation of the earth cable may produce an electric shock.

■ Safety precautions

■ OPERATION PRECAUTIONS

⚠ WARNING



- **Children shall not play with the appliance.**
- **Do not expose yourself to the cooling air for a long period.**
This could affect your physical condition and cause health problems.
- **Cleaning and user maintenance shall not be made by children without supervision.**
- **Do not insert anything into the air inlet.**
This may cause injury, as the internal fan rotates at high speed.



- **This appliance can be used by children aged from 8 years and above and persons with reduced physical, sensory or mental capabilities or lack of experience and knowledge if they have been given supervision or instruction concerning use of the appliance in a safe way and understand the hazards involved.**
- **Store the remote control out of reach of infants.**
Failure to observe this may result in the batteries being swallowed or other accidents.

⚠ CAUTION



- **Only use approved fuses.**
Use of steel or copper wire instead of an approved fuse is strictly prohibited, as it may cause a breakdown or fire.
- **Do not handle the switches with wet hands.**
This may cause an electric shock.
- **Do not swing from the indoor unit.**
If the indoor unit falls down, you may get injured.
- **Do not place a flammable insecticide or paint spray near the blower, nor spray it directly on the system.**
This may result in a fire.
- **You should not expose any combustion appliance directly to the air stream of the air-conditioner.**
The appliance may then work inadequately.
- **Do not wash the air-conditioner with water.**
This could cause an electric shock.
- **The system should only be used for its original purpose and not for anything else like, for instance, preservation of food, plants or animals, precision devices or works of art.**
The system is only intended for use in ordinary domestic rooms. Any other use of the system may damage the quality of food, etc.
- **Do not place anything containing water, like vases, on top of the unit.**
Water entering the unit could damage the insulation and therefore cause an electric shock.
- **Do not install the system where the airflow direction is aimed directly at plants or animals.**
This will damage their health.
- **Do not sit on the outdoor unit nor put anything on it.**
If the unit falls down or things drop off it, people could get hurt.
- **After a long period of use, check the unit's support structure from time to time.**
If you do not repair any damage right away, the unit may fall down and cause personal injury.

■ Safety precautions

⚠ CAUTION



- **Do not touch the aluminum fins on the air heat exchanger.**
It may result in injury.
- **Do not place household electrical appliances or household items under neath the indoor or outdoor units.**
Condensation falling from the unit may stain objects and cause accidents or electrical shock.
- **Do not operate the system without the air filter.**
It can cause malfunction of the system due to clogging of the heat exchanger.
- **Do not shut off the power supply immediately after stopping the operation.**
Wait at least 5 minutes, otherwise there is a risk of water leakage or breakdown.
- **Do not control the system with main power switch.**
It can cause fire or water leakage. In addition, the fan can start unexpectedly, which can cause personal injury.
- **Do not pour liquid into this unit and do not put water container on this unit.**
Water entering the unit could damage the insulation and therefore cause an electric shock.



- **If you operate the system together with a combustion appliance, you must regularly ventilate the indoor air.**
Insufficient ventilation may cause accidents due to oxygen deficiency.
- **Stand firmly on a stepladder or other stable object when removing the inlet panel and filters.**
Failure to observe this may result in injury through insecure objects toppling over.
- **When you clean the system, stop the unit and turn off the power supply.**
Never open the panel while the internal fan is rotating.
- **Do not place objects near the outdoor unit or allow leaves to gather around the unit.**
If there are objects or leaves around the outdoor unit, small animals may enter unit and contact electrical parts and may cause a break-down, smoke or fire.
- **Contact your dealer to clean inside the indoor unit, do not attempt to do by yourself.**
The use of a non-approved detergent or improper washing method may damage the unit's plastic components and cause leaks. Damage, smoke, or fire may also happen if the detergent comes in contact with electrical parts or the unit's motor.
- **Stop the unit and turn off the power if you hear thunder or there is a danger of lightning.**
It may damage the unit.
- **Do not let the foreign matters enter the indoor unit through the air outlets.**
This may cause the dumper inoperable.
- **If the power cord becomes damaged, contact your dealer or a qualified engineer.**
If it is not replaced, it may cause a breakdown or fire.

■ Safety precautions

■ PRECAUTIONS FOR RELOCATION OR REPAIRS

WARNING



- **Do not perform any repairs or modifications by yourself. Consult the dealer if the unit requires repair.**

If you repair or modify the unit, it can cause water leaks, electric shocks or fire.



- **Consult your dealer for repairs.**

Wrong repairs could cause an electric shock, fire, etc.

- **In case the air-conditioner is relocated elsewhere, contact your dealer or a professional fitter.**

Faulty installation may cause water leakage, electric shock, fire, etc.

- **If you notice anything abnormal (smell of burning, etc.), stop the system, turn off the power supply and consult your dealer.**

Continued use of the system in abnormal circumstances may result in malfunctioning, electric shock, fire, etc.

- **If the air-conditioner fails to cool or warm the room, it may have a refrigerant leakage. Contact your dealer. If refrigerant needs to be added, check with your dealer for proper instructions.**

If the refrigerant comes in contact with the bare skin, it may cause cold injury.

If the refrigerant gas is inhaled excessively, it may cause deterioration of nerve function like dizziness and headache, or deterioration of heart function like irregular heartbeat and heart palpitation temporarily. If refrigerant unexpectedly leaks from the unit onto a fan heater, stove, hotplate or other heat source, harmful gases could be generated.

Name of each part and its function

INDOOR UNIT

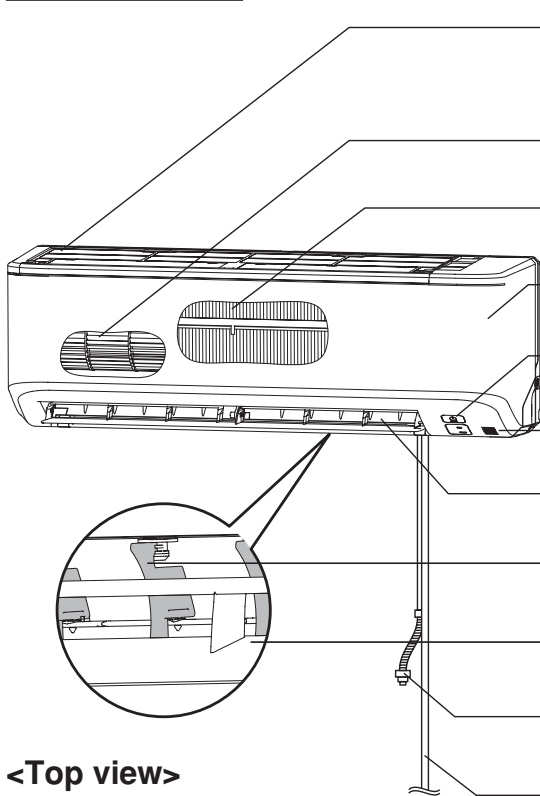

Air filter

Remove dust or dirt from the inlet air.

👉 Page 18

Indoor unit fan

Heat exchanger

Front panel

Unit display section

👉 Page 7

Room temperature sensor

Air outlet

Air blows out of here.

Left/right airflow direction adjustment louver

👉 Page 12

Up/down airflow direction adjustment flap

👉 Page 12

Drain hose

Drains water from the indoor unit.

Refrigerant piping connection and electric wire

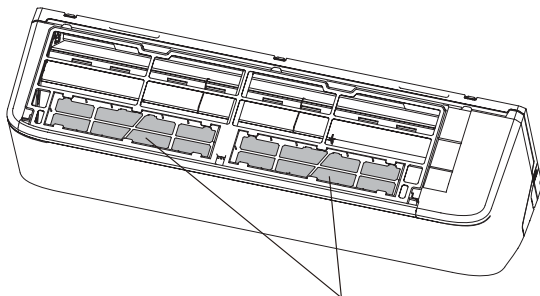

Air-cleaning filter

👉 Page 19

OUTDOOR UNIT

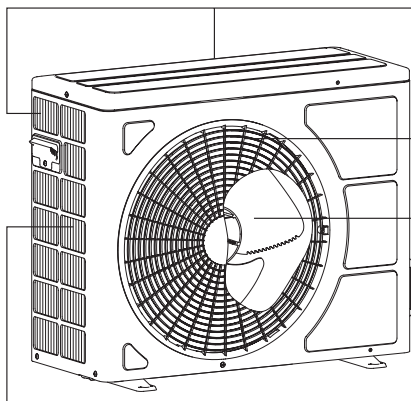

Air inlet

(On side & rear surface)

Air outlet

Outdoor unit fan

Heat exchanger

Name of each part and its function

Unit display section

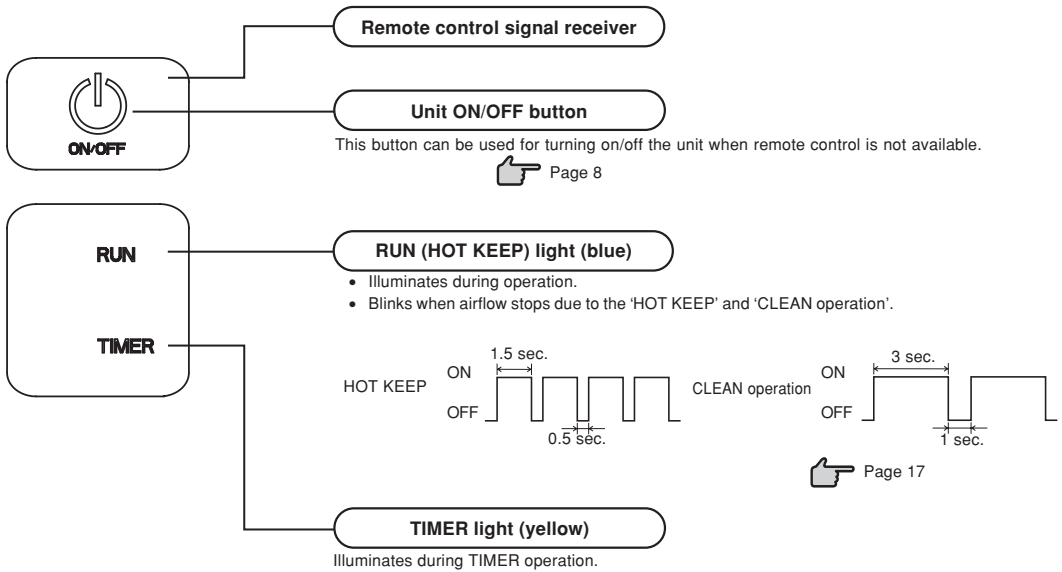

Accessories



Wireless remote control

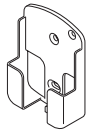

Wireless remote control holder



Battery
(R03 (AAA, Micro) x2)



Wood screw (Quantity:2)
(for remote control holder mounting)

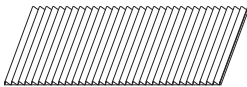

Natural enzyme filter
(Green)

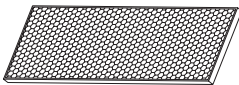

Photocatalytic washable
deodorizing filter (Orange)

Installing

1. Remove the air filter.
2. Remove the filter holders, with the air-cleaning filter installed in the holders, from the air filter.
3. Install the air-cleaning filter in the filter holders, and then install the filter holders in the air filter.
4. Install the air filter.

➔ Page 18, 19

NOTE

• Buzzer sound for remote control

When preset temperature 24°C, automatic operation and automatic airflow are selected, the buzzer sound (PiPi) is produced. When turning off the air conditioner by pressing ON/OFF button (except CLEAN mode), the buzzer sound (Pi) is produced. This function is useful for operating the air conditioner in the darkness.

Air flow setting

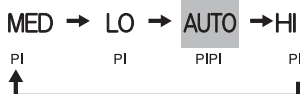

Preset temperature



Remote control handling

Replacing the batteries

The following cases signify exhausted batteries. Replace old batteries with new ones.

- Receiving beep is not emitted when a signal is transmitted.
- Display fades away.

1 Pull out the cover and take out old batteries.

2 Insert new batteries. R03 (AAA, Micro) x2

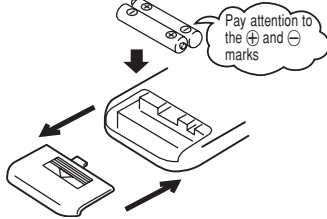

3 Close the cover.

4 Press the ACL switch with the tip of a ballpoint pen.

The timer setting mode is displayed.



NOTE

- Do not use old and new batteries together.
- Remove the batteries when the remote control is not used for a long period.
- The recommended effective period of a battery conforming to JIS or IEC should be 6 to 12 months with normal use. If used longer, or when an unspecified battery is used, liquid may leak from the battery, causing the remote control to malfunction.
- The recommended effective period is printed on the battery. This may be shorter due to manufacturing time to the unit. However, the battery may still be in working order after expiry of its nominal life.

- When the display shows any abnormal condition, Press the ACL switch with the tip of a ballpoint pen.

Using the remote control holder

The remote control can be attached to a wall or pillar by using a remote control holder. Before installing the remote control, check that the air-conditioner receives the signals properly.

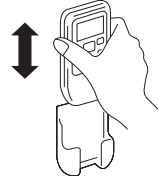

For installing or removing the remote control, move it up or down in the holder.

Warning note for remote control handling

⊘ Strictly prohibited

- | | | |
|-----------------------------------------------------------------------------------------------------------------------------------|------------------------------------------------------------------------------------------------------------------------------------------|----------------------------------------------------------------------------------------------------------------------|
| <ul style="list-style-type: none"> • Do not go near high temperature places, such as an electric carpet or stove. | <ul style="list-style-type: none"> • Do not leave the remote control exposed to direct sunlight or other strong lighting. | <ul style="list-style-type: none"> • Do not drop the remote control. Handle with care. |
| <ul style="list-style-type: none"> • Do not put any obstructing obstacles between the remote control and the unit. | <ul style="list-style-type: none"> • Do not spill any liquid on the remote control. | <ul style="list-style-type: none"> • Do not place heavy objects on the remote control, or step on it. |

Operation failure with the remote control

• Are the batteries running down?



"Replacing the batteries" above.

Replace the batteries with new ones and retry the operation.

• If the operation fails, operate the unit with temporary operation function.

Contact your dealer to have the remote control checked.



Below

Temporary run operation

- The unit ON/OFF button on the unit operates ON/OFF temporarily when the remote control is not used.

Operation program

- OPERATION MODE : AUTO
- FAN SPEED : AUTO
- AIR FLOW : AUTO

- Operation starts by pressing the unit ON/OFF button; it stops if you press the button again.

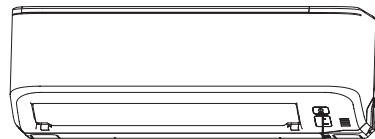

Unit ON/OFF button

NOTE

- Do not hold the Unit ON/OFF button down for more than 5 seconds. (Holding it down longer than 5 seconds sets the automatic cooling used during servicing or when relocating the air-conditioner.)

Operation and display section for remote control

Operation section

FAN SPEED button

Each time the button is pressed, the ■ display is switched over in turn.

👉 Page 10

HI POWER/ECONO button

This button changes the HIGH POWER/ECONOMY mode.

👉 Page 16

TEMPERATURE button

These buttons set the room temperature. (These buttons are used for setting the current time and timer function as well.)

ON TIMER button

This button selects ON TIMER operation.

👉 Page 14

SLEEP button

This button selects SLEEP operation.

👉 Page 13

CLEAN switch

This switch selects the CLEAN mode.

👉 Page 17

CANCEL button

This button cancels the ON timer, OFF timer, and SLEEP operation.

OPERATION MODE select button

Each time the button pressed, the ■ display is switched over in turn.

👉 Page 10, 11

ON/OFF (luminous) button

Press to start operation, press again to stop.

AIR FLOW (UP/DOWN) button

This button changes the air flow (up/down) direction.

👉 Page 12

OFF TIMER button

This button selects OFF TIMER operation.

👉 Page 13

ACL switch

This switch is for resetting microcomputer and setting time.

👉 Page 8

• The above illustration shows all controls, but in practice only the relevant parts are shown.

Transmission procedure

When each button on the remote control is pressed – with the remote control pointing towards the air-conditioner unit a signal is transmitted. When the air-conditioner receives the signal correctly, it will beep.

Current time setting

- When inserting the batteries, the current time is automatically set to time setting mode. 10:00 is displayed as the current time. Set the clock to the right time.

Example: Set to 10:30.

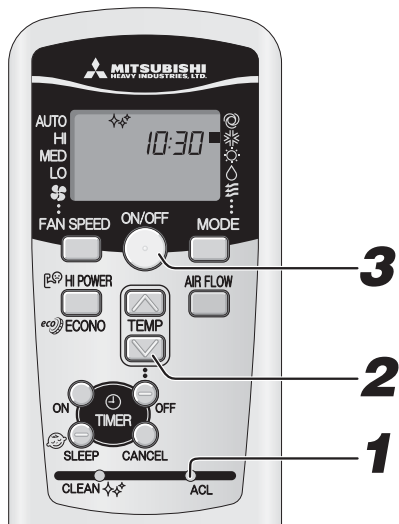

1 Press the ACL switch.

Press with the tip of a ballpoint pen, etc. The time display blinks and can be set to the current time.

2 Press the ⬆ or ⬇ button.

(Set to 10:30)

3 Press the ON/OFF button.

The display changes from blinking to steady lighting and the setting is complete. Make sure to press the button within 60 seconds from the last operation in step 2, otherwise the time is not set.

NOTE

- The timer operation works based on the time clock, so please set it correctly.
- The remote control data is reset when the present time is set.

AUTO mode operation

- Automatically selects the operation mode (COOL, HEAT, DRY) depending on the room temperature when switched on.

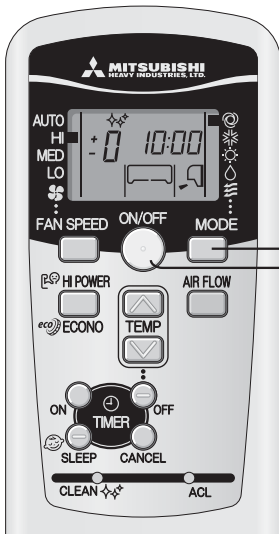

When the unit is not in AUTO mode:

1 Press MODE button.
Move the [■] mark to the (Auto) position.

Point the remote control toward the air-conditioner, and

2 Press the ON/OFF button.

To stop: Press the ON/OFF button.

NOTE

- In case air is not blowing out during the operation. Page 21

Display in OFF status



- The current time and preset OPERATION MODE are displayed while the air conditioner is turned off.

- If you do not want the AUTO mode program, change to COOL, HEAT, DRY or FAN instead of AUTO. Page 11
- Airflow direction adjustment procedure. Page 12

Temperature adjustment during AUTO

- Air temperature adjustment is possible even during automatic operation. There are 6 levels of adjustment possible with the (∇) button or the (▽) button. During automatic operation, 24°C is preset both for heating and cooling.

When a change in temperature is required.

1 Press the (∇) or (▽) button.

When it is a little cold

Press the (∇) button.

- Each time the (∇) button is pressed, the switch over occurs in the following order -6 → -5 → -1 → ±0 → +1 +6. When +6 is indicated, even if the (∇) button is pressed, the indicator does not change.

When it is a little hot

Press the (▽) button.

- Each time the (▽) button is pressed, the switch over occurs in the following order +6 → +5 → +1 → ±0 → -1 -6. When -6 is indicated, even if the (▽) button is pressed, the indicator does not change.

	Remote Control display												
Setting	-6	-5	-4	-3	-2	-1	±0	+1	+2	+3	+4	+5	+6
temp.(°C)	18	19	20	21	22	23	24	25	26	27	28	29	30

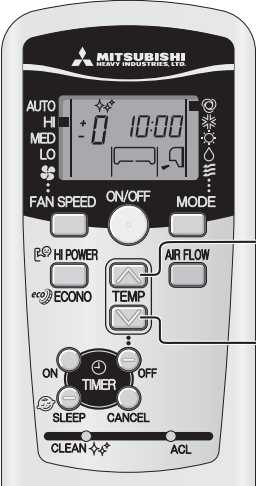

FAN SPEED

- You can choose the capacity of your air-conditioner when heating mode, cooling mode or fan mode.

Operation capacity by your choice	FAN SPEED
Set automatically by microcomputer	AUTO
Powerful operation with high capacity	HI
Standard operation	MED
Energy-saving operation	LO

Press the FAN SPEED button.

Move the [■] mark to the preferred fan speed position.

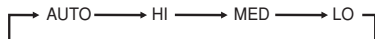

NOTE

- When changing FAN SPEED from HI to LO, the sound of refrigerant flowing may be heard.

COOL/HEAT/DRY/FAN mode operation

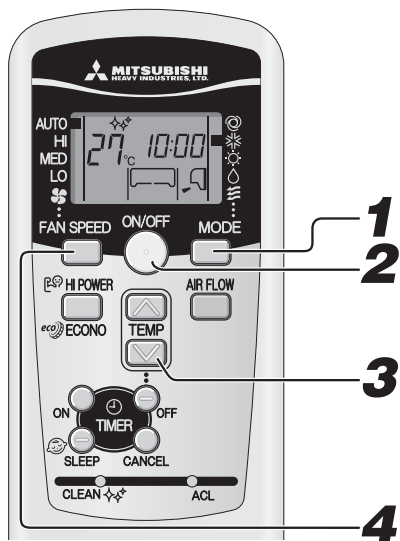

Airflow direction adjustment procedure. Page 12

NOTE

- In case air is not blown out, when starting the heating operation. Page 21
- The operation program can also be set or changed when the air-conditioner is not in operation.

Point the remote control toward the air-conditioner, and

1

Press the MODE select button.

Move the [■] mark to the required operation position.

※ (Cool), ☀ (Heat), ◊ (Dry), ⌘ (Fan)

2

Press the ON/OFF button.

3

Press the TEMP button.

Press or button for the preferred temperature.

Recommendation

COOL	26°C~28°C	HEAT	22°C~24°C	DRY	24°C~26°C	FAN	--
------	-----------	------	-----------	-----	-----------	-----	----

4

Press the FAN SPEED button

Set the fan speed as preferred.

To stop:

Press the ON/OFF button.

Air-conditioner operable temperature setting

- Use within the following operational range. Operating outside of this range may result in the protection devices being activated, preventing the unit from working.

	Cooling operation	Heating operation
Outside temperature	Approximately -15 °C to 46 °C	Approximately -15 to 24 °C
Inside temperature	Approximately 18 to 32 °C	Approximately 15 to 30 °C
Inside humidity	Below approximately 80% The long-term use of the unit with a humidity level exceeding 80% may result in condensation forming on the surface of the indoor unit, leading to water drips.	—

Characteristics of HEAT mode operation

Mechanism and capacity of HEAT mode operation

■ Mechanism

- The unit draws heat from the cold outside air, transfers it to indoors and heats the room. As a characteristic of heat pump system, the heating capacity reduces when the outside air temperature gets colder.
- It may take some time to supply hot air after turning on the air-conditioner.
- If the outside temperature becomes extremely low, it would be better to use an additional source of heating.

Defrosting

If the outside temperature becomes low and humidity is high, the heat exchanger in the outdoor unit may frost over, which prevents efficient heating.

If this happens, the automatic defrost function is activated and during defrosting the heating operation stops for 5 to 15 minutes during defrosting.

- Both indoor and outdoor fans stop and the RUN light blinks slowly (1.5 sec. ON, 0.5 sec. OFF) during defrosting.
- The outdoor unit may give off some steam during defrosting. This is to help the defrosting process and is not a defect.
- The HEAT operation resumes as soon as defrosting has been completed.

Airflow direction adjustment

Adjusting airflow direction

- Up/down direction can be adjusted with the AIRFLOW button on the remote control. Every time you press this button the mode changes as follows:
Change on AIRFLOW (UP/DOWN) mode.

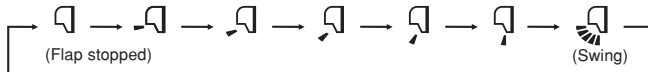

NOTE FOR HEATING OPERATION

- When operation starts, the flap direction is fixed at the horizontal position in order to avoid cold draft, and return to the set position that was set after the warm air supply is starting.
- The flap direction will be controlled to the horizontal position when the room temperature reaches the set temperature and compressor stops or when defrosting is in operation.
- The airflow direction cannot be set during the period mentioned above. Change the airflow direction settings after the warm air is supplied and the flap goes to the set position.

MEMORY FLAP (FLAP STOPPED)

When you press the AIRFLOW button once while the flap is operating, it stops swinging at the position. Since this angle is memorized in the microcomputer, the flap will automatically be set at this angle when the next operation is started.

⚠ WARNING

- Do not expose directly to airflow from the air-conditioner for a long time.

⚠ CAUTION

- When in COOL or DRY operation, do not operate for a long period with the airflow blowing straight down. Otherwise, condensation may appear on the outlet grill and drip down.
- Do not try to adjust the flaps by hand, as the control angle may change or the flap may not be closed completely.

- Recommended angle of the flap when stopping

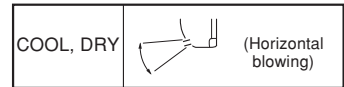
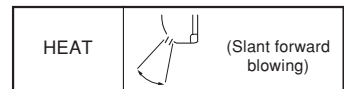

Adjusting left/right air flow direction

- Adjust the direction by moving the left/right louver by hand.
When you adjust the direction, touch the operation point of louver.

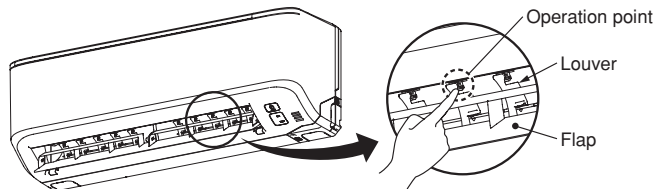

⚠ CAUTION

- Please stop the air conditioner when adjusting the air flow direction.

SLEEP TIMER operation

- The unit stops automatically after the set time lapses.

The set temperature is automatically adjusted according to the elapsed time in order to avoid too much cooling or heating.  Page 15

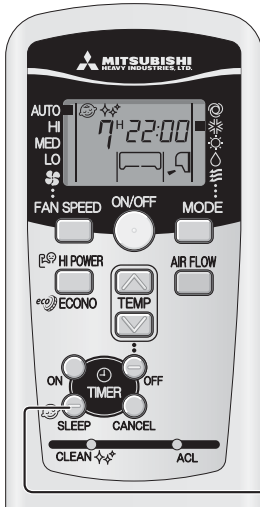

1 Press the SLEEP button.

- If it is pressed while the unit is off**

SLEEP TIMER operation starts with the previous operation settings, and the air conditioning is turned off after the set time elapses.

- If it is pressed while the unit is running**

The air conditioner is turned off after the set time elapses.

Every time the button is pressed, the display changes as follows:

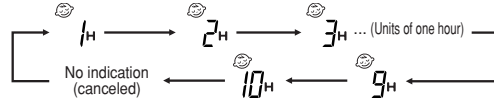

Example: You prefer it to stop after 7 hours.

Set to 

The timer light (yellow) is on.

- The unit stops after the set time lapses.

Changing of set time

Set a new time by pressing SLEEP button.

How to cancel

Press the CANCEL button to turn off the SLEEP display.

NOTE

- Cannot be set at the same time with OFF-TIMER.

OFF-TIMER operation

- The unit stops automatically when the set time comes.

With the air conditioner turned off, start the operation from Step 1. With the air conditioner running, start from Step 2.

Example: You prefer it to stop 22:30.

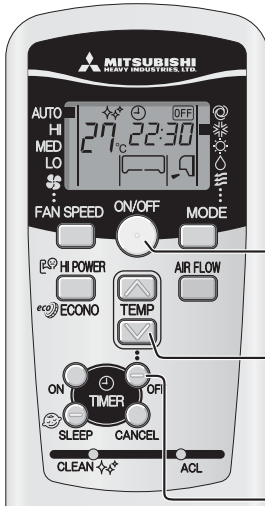







1 Press the ON/OFF button.

2 Press the OFF TIMER button.





OFF TIMER display  is blinking.

3 Press the or button.

Every time the  button is pressed, the display is switched in the order of:

 →  →  → ... →  →  (Units of ten minutes)

Every time the  button is pressed, the display is switched in the order of:

 →  →  → ... →  →  (Units of ten minutes)

Set at 22:30.

4 Press the OFF TIMER button.

The display changes from blinking to steady lighting and the setting is complete. The timer light (yellow) is on.

Changing of set time

Set a new time by using the OFF TIMER button.

How to cancel

Press the CANCEL button to turn off the timer display.

NOTE

- The unit stops at the end of the set period of time.
- Make sure to press the button within 60 seconds from the last operation in step 3, otherwise the setting is not completed.
- The current time is not displayed during OFF-TIMER operation.
- Different from SLEEP TIMER operation, automatic set temperature adjustment is not done during OFF-TIMER operation.



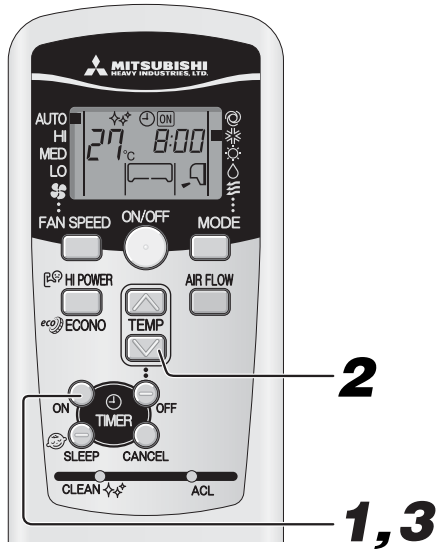

ON-TIMER operation

- Operation starts 5 to 60 minutes before the set time so that the room temperature reaches the optimum temperature at the set time.  Page 15
ON-TIMER operation can be set regardless of whether the air-conditioner is running or not.

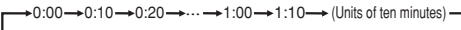

Example: In the case the preferred room temperature is required at 8:00.

1 Press the ON-TIMER button.
ON TIMER display  is blinking.

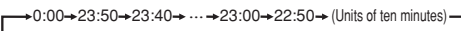
2 Press the  or  button.
Every time the  button is pressed, the display is switched in the order of:
 → 0:00 → 0:10 → 0:20 → ... → 1:00 → 1:10 → (Units of ten minutes)
Every time the  button is pressed, the display is switched in the order of:
 → 0:00 → 23:50 → 23:40 → ... → 23:00 → 22:50 → (Units of ten minutes)
Set at 8:00.

3 Press the ON TIMER button.
The display changes from blinking to steady lighting and the setting is complete.
The timer light (yellow) is on.
The operation stops if it is set during operation.

NOTE

- Operation starts 5 to 60 minutes before the set time.
- The timer light (yellow) goes out at the set time.
- Make sure to press the button within 60 seconds from the last operation in step 2, otherwise the setting is not completed.
- The current time is not displayed during ON-TIMER operation.

Changing of set time

Set a new time by using the ON-TIMER button.

How to cancel

Press the CANCEL button to turn off the timer display.

SLEEP TIMER + ON-TIMER operation

- Combined timer operation of SLEEP TIMER and ON TIMER.

Example: When it is required to stop after 3 hours and then start operation at 8:00, near the set temperature.



SLEEP TIMER setting

Set by the procedures on page 13.

Set to  3H

ON TIMER operation setting

Set by the above procedure mentioned in ON TIMER.

Set to  8:00

The setting of the lighting of the timer light (yellow) of this unit is complete.

- After the SLEEP TIMER set time has elapsed, the operation stops, and it starts from 5 to 60 minutes before the ON TIMER's set time.
- The timer light is turned off when ON TIMER set time comes.

Changing of set time

Set a new time by using the SLEEP or ON TIMER button.

How to cancel

Press the CANCEL button to turn off the timer display.

PROGRAM TIMER operation

- The timer operations of the combination of ON and OFF TIMER. Once this has been set the timer operations will be repeated at the same time every day unless the ON/OFF button is pressed.

Example: When it is preferred to stop at 22:30, and then start operation at 8:00, near the set temperature.



■ OFF TIMER operation setting

Set by the procedures on page 13. Set to OFF 22:30

■ ON TIMER operation setting

Set by the procedures on page 14. Set to ON 8:00

Timer light (yellow) on the unit will light when the setting is completed.

The set time will be displayed on the remote control unit. The display will change depending on the operational status.

ON/OFF 8:00 With ON TIMER, the air conditioner starts running. Then, with OFF TIMER, the air conditioner stops running.

ON/OFF 22:30 With OFF TIMER, the air conditioner stops running. Then, with ON TIMER, the air conditioner starts running.

Changing of set time

Set a new time by using the OFF TIMER or ON TIMER button.

How to cancel

Press the CANCEL button to turn off the timer display.

Comfort Start-up

In ON TIMER operation, the unit starts the operation a little earlier, so that the room can approach optimum temperature at ON time. This is so called "Comfort start-up".

- Mechanism

The room temperature is checked 60 minutes before the ON time. Depending on the temperature at that time, the operation starts 5 to 60 minutes before the timer is at ON.

- The function is available for both COOL and HEAT operation mode (including AUTO). It does not work for DRY mode.

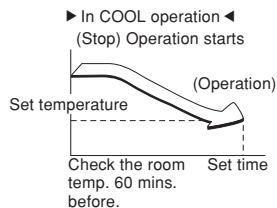

SLEEP TIMER

When SLEEP TIMER is selected, the set temperature is automatically adjusted after a while, ensuring that the room is not too cold during cooling or too warm during heating.

- During cooling : The preset temperature is lowered by 1°C at the start of SLEEP operation (when the timer is set). After that, the temperature goes up by 1°C every an hour to become 1°C higher than the present temperature.
- During heating: The preset temperature is lowered by 1°C at the start of SLEEP operation (when the timer is set). After that the temperature becomes 3°C lower in an hour and 6°C lower in two hours than the present temperature.

HIGH POWER/ECONOMY operation

If the air-conditioner is not operating, point the remote control toward the air conditioner, and

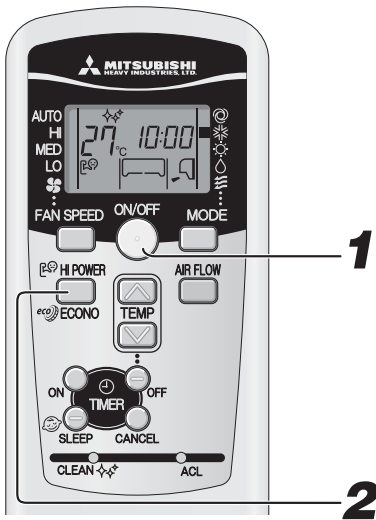

1 Press the ON/OFF button.

2 Press the HI POWER/ECONO button.

- When the operating mode is AUTO, COOL or HEAT
Every time the HI POWER/ECONO button is pressed, the display is switched in the order of:



- When the operating mode is DRY or PROGRAM TIMER
Every time the HI POWER/ECONO button is pressed, the display is switched in the order of:

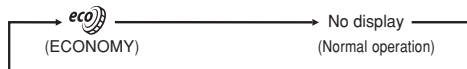

Concerning HIGH POWER operation

Pressing the HI POWER/ECONO button intensifies the operating power and initiates powerful cooling or heating operation for 15 minutes continuously. The remote control displays and the FAN SPEED display disappears.

NOTE

- During the HIGH POWER operation, the room temperature is not controlled. When it causes an excessive cooling or heating, press the HI POWER/ECONO button again to cancel the HIGH POWER operation.
- HIGH POWER operation is not available during the DRY and the program timer operations.
- When HIGH POWER operation is set after ON TIMER operation, HIGH POWER operation will start from the set time.
- When the following operations are set, HIGH POWER operation will be canceled.
 - When the HI POWER/ECONO button is pressed again.
 - When the operation mode is changed.
 - When it has been 15 min. since HIGH POWER operation has started.
- Not operable while the air conditioner is OFF.

Concerning ECONOMY operation

Pressing the HI POWER/ECONO button initiates a soft operation with the power suppressed in order to avoid an excessive cooling or heating. The unit operates 1.5°C higher than the setting temperature during cooling or 2.5°C lower than that during heating. The remote control displays and the FAN SPEED display disappears.

NOTE

- It will go into ECONOMY operation at the next time the air-conditioner runs in the following case.
 - When the air-conditioner is stopped by ON/OFF button during ECONOMY operation.
 - When the air-conditioner is stopped in SLEEP or OFF TIMER operation during ECONOMY operation.
 - When the operation is retrieved from CLEAN operation.
- When the following operations are set, ECONOMY operation will be canceled.
 - When the HI POWER/ECONO button is pressed again.
 - When the operation mode is changed from DRY to FAN.
- Not operable while the air conditioner is OFF.

SELF CLEAN operation

- CLEAN operation should be run after AUTO, COOL and DRY operation to remove the moisture from inside the indoor unit and control the growth of mold and bacteria.



1 In order to active CLEAN operation, press the CLEAN switch with the tip of a ballpoint pen.

Every time the CLEAN switch is pressed, the display is switched in the order of:



NOTE

- Two hours later, the air conditioner stops running automatically. To stop the air conditioner immediately, press the ON/OFF button.
- CLEAN operation is not operated after HEAT, FAN, OFF-TIMER and SLEEP operations have finished.
- The indoor unit fan runs for about two hours in CLEAN operation.
- The RUN light illuminates during CLEAN operation.

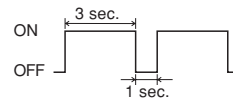

- Pressing the SLEEP button during CLEAN operation cancels the CLEAN operation and then the unit is set to SLEEP operation.
- This is not a function for removing mold, germs or grime that have already adhered to the unit.

Auto restart function

What is auto restart function?

- Auto restart function records the operational status of the air-conditioner immediately prior to be switched off by a power cut, and then automatically resumes operations after the power has been restored.
- The following settings will be canceled:
 - Timer settings
 - HIGH POWER operations

NOTE

- Auto restart function is set at on when the air-conditioner is shipped from the factory. Consult with your dealer if this function needs to be switched off.
- When power failure occurs, the timer setting is canceled. Once power is resumed, set the timer again.

Tips for effective operation

- Please observe the following for the most economic and comfortable use of your unit.

<p>Set a suitable room temperature.</p> <p>Excessively high or low temperatures are not good for your health and waste of electricity.</p>	<p>Clean the filter frequently.</p> <p>Clogged filter may block the airflow and cause less efficient operation.</p>	<p>Avoid direct sunlight and draught.</p> <p>Cut out direct sunlight by drawing the curtains or blinds when cooling. Keep windows and doors shut, except when ventilating.</p>
<p>Adjust the airflow direction properly.</p> <p>Adjust the up/down and left/right airflow to ensure a steady room temperature.</p>	<p>Operate the unit only when needed.</p> <p>Use the timer properly to operate the unit only when needed.</p>	<p>Keep heat source away when cooling.</p> <p>Keep heat sources out of the room as much as possible.</p>

Maintenance

Careful matter during maintenance

Turn off the power supply.



- Do not spill any liquid.

Wipe the unit with a soft, dry cloth.

There's a danger of electric shock.



- Do not touch the aluminum fins on the heat exchanger.
- Stand firmly on a stepladder or other stable object when removing the filter.

Do not use the following articles:

- Hot water (40°C or more)
It may deform or discolour the unit.
- Petrol, paint thinner, benzine or cleanser, etc.
They may deform or scratch the unit.

During the operational season

1 Cleaning the air filter Recommendation interval is once every two week

- Hook fingers on this side of the top face of air filter. Pull the air filter forward. The air filter will separate from front panel.

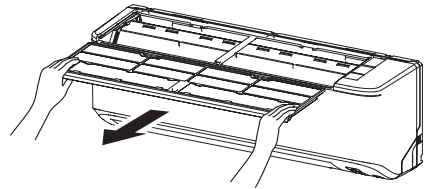

CAUTION

- When removing the air filter, pull it out gently without tilting and with care not to shake off dirt accumulated on the air filter.
- Be careful not to allow dirt shaken off the air filter entering in the eyes or mouth.

2 Cleaning

Remove dirt from the air filter using a vacuum cleaner. If the filter is very dirty, clean it with warm water (approx. 30°C), and dry it thoroughly.

CAUTION

- Do not clean the filter with boiling water.
- Do not dry them over an open flame.
- Pull them out gently.

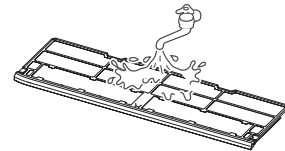

3 Reinstall the air filter

- Insert the air filter's ditch to the rail of the front panel and push it in the back.

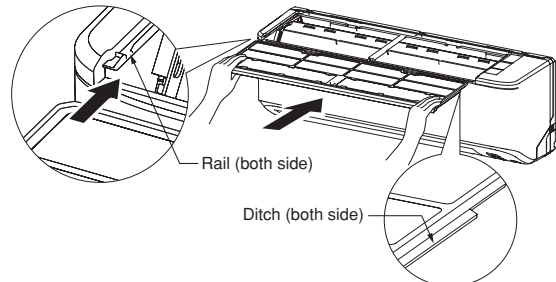

CAUTION

- Operating without putting back the air filter will make the unit dusty, and may cause damage.

Cleaning the unit

- Wipe the unit with a soft, dry cloth, or use a vacuum cleaner.
- If the unit is very dirty, wipe it with a cloth soaked in warm water.

NOTE

Cooling/heating is affected by an air filter clogged up with dust etc., and the operation noise becomes louder. It may also use extra electricity. Please clean the air filter at recommendation intervals.

At the end of the season

- 1 Perform the fan operation for a half day.**
Dry the inside of the unit.
Cooling season only.
- 2 Stop the unit and turn off the power supply.**
The unit consumes approx. 2W even when the unit is not operating. Turning off the power supply will help saving energy consumption and cost.
- 3 Clean and reinstall the air filter.**
- 4 Clean both the indoor and outdoor units.**
- 5 Remove batteries from the remote control.**

At the beginning of the season

- 1 Make sure that there are no obstacles blocking the airflow around the air intake and outlet openings of the indoor and outdoor units.**
- 2 Check if there is no corrosion or rust on the base frame of the outdoor unit.**
- 3 Ensure that the earth wiring is not snapped nor disconnected.**
- 4 Ensure that the air filter are clean.**
- 5 Turn on the power supply.**
- 6 Insert batteries in the remote control.**

Installing, inspecting and replacing the air-cleaning filter

1. Remove the air filter.  Page 18
2. Remove the filter holders, with the air-cleaning filter installed in the holders, from the air filter.
3. Remove the photocatalytic washable deodorizing filter (orange) from the filter holder and inspect the filter. Periodically, remove any dust or dirt from the photocatalytic washable deodorizing filter. If the photocatalytic washable deodorizing filter is particularly dirty, it may be washed with water. However, the filter is fragile so be sure to wash it installed in the filter holder to avoid damaging it. After washing the filter, place it in sunlight to dry. Placing the filter in sunlight revitalizes the deodorizing effect.

Remove the natural enzyme filter (green) from the filter holder and inspect the filter. Use a vacuum cleaner to remove any dust or dirt from the natural enzyme filter. Replace the natural enzyme filter if it cannot be cleaned or if it has been used for about 1 year.

(The natural enzyme filter should be replaced after about 1 year of use. However, the actual replacement period may vary depending on the conditions in which the filter is used.)

(Do not dispose of the filter holders. They are reused.)

4. Install the air-cleaning filter in the filter holders, and then install the filter holders in the air filter.

NOTE

- The natural enzyme filter and the photocatalytic washable deodorizing filter may be installed on either the right or left side of the air filter.
- Place the natural enzyme filter with the green side upper.

5. Install the air filter.  Page 18

CAUTION

- Do not expose natural enzyme filters to direct sunlight for an extended period. The bacteriolytic effect will be lost.

For replacement the air-cleaning filter, contact your dealer.

Item	Feature	Color
Photocatalytic washable deodorizing filter	Sources of odors on the filter are broken up, resulting in a deodorizing effect.	Orange
Natural enzyme filter	By using the work of enzyme, mold and bacteria on the filter are destroyed and the room air is kept clean.	Green

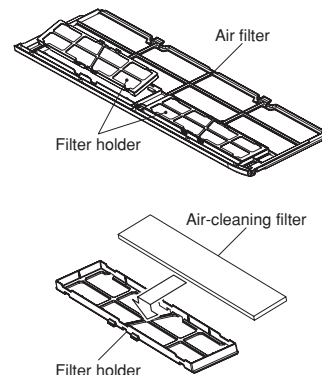

Proper installation

Suitable installation position

- Do not put any obstruction in front of the indoor unit, preventing proper ventilation and functioning.
- Do not install the unit in any of the following places:
 - Where there is a danger of leaking flammable gases.
 - Where there is substantial splashing of oil.
- Malfunctioning due to corrosion may occur if the unit is installed in a spa where sulfide gases are generated, or in a seaside resort exposed to sea breezes. Contact your dealer.
- The air-conditioner and remote control must be at least 1 metre away from a TV set or radio.
- Drain the dehumidified liquid from the indoor unit into a spot that drains well.

Pay attention to operating noises!

- When you install the unit, take care to choose a place that can comfortably stand the weight of the unit and does not increase the operating noise or vibration. If vibration is transmitted through the house, fix the unit with the aid of vibration-proof pads between the unit and the fittings.
- Select a place where cold or hot air, operation noises from the indoor and outdoor units do not cause any inconvenience to your neighbours.
- Do not leave any obstacles near the outlet and inlet of the outdoor unit. This may cause malfunctioning and increased operating noise.
- If you hear an irregular noise during operation, contact your dealer.

Inspection and maintenance

Depending on operating environment, the inside of the air-conditioner may become dirty after a few year operations. This will reduce performance. In addition to normal cleaning, we would recommend inspection and maintenance. (This may lead the air-conditioner to having a longer life without any trouble.)

- Contact your dealer, or any distributor, for inspection and maintenance. (There will be a charge for this service).
- We would recommend inspection and maintenance to be carried out during the off-season.
- If the supply cord of this appliance is damaged, it must only be replaced by a repair shop appointed by the manufacturer, because special purpose tools are required.

Troubleshooting

Please carry out the following checks before making a service call.

The air-conditioner does not work at all.

Has the power switch been turned off?	Has the timer been set in the "ON" position?	Is there a power failure or a blown fuse?
---------------------------------------	----------------------------------------------	-------------------------------------------

Poor cooling or heating

Have you set the thermostat at a suitable temperature?	Is the air filter clean? (Not clogged?)	Did you leave any doors or windows open?
--------------------------------------------------------	-----------------------------------------	------------------------------------------

Poor cooling

Is there any direct sunlight entering the room?	Is there a heat source in the room?	Are there too many people in the room?
-------------------------------------------------	-------------------------------------	----------------------------------------

If the air-conditioner does not operate properly after you have checked the above points, or if any doubt still exists after you have consulted page 21, or if things happen as shown on page 22, switch off the power and contact your dealer.

An alternative refrigerant (R410A) is used in this air-conditioner. When asking your dealer for service or inspection and maintenance, explain the dealer about it.

Notice

<p>The unit does not restart immediately after you have stopped it.</p> <p>(RUN light is on)</p>	<p>Restart is blocked for 3 minutes after you have stopped the operation to protect the unit. The three-minute protection timer in the microcomputer automatically starts it up again.</p>
<p>Airflow is not blown out when starting the HEATING operation.</p> <p>RUN light blinks slowly (1.5 sec ON, 0.5 sec OFF)</p>	<p>Airflow has stopped to prevent blowing out of cold air until the indoor heat exchanger has warmed up. (2 to 5 min.) (HOT KEEP program)</p>
<p>Airflow is not blown out for 5 to 15 min. or blown out not warm wind for a moment at HEATING operation.</p> <p>RUN light blinks slowly (1.5 sec ON, 0.5 sec OFF)</p>	<p>When outdoor temperature is low and humidity is high, the unit sometimes performs defrosting automatically. Please wait. During defrosting, water or steam may escape from the outdoor unit.</p>
<p>Airflow is not blown out when starting the DRY operation.</p> <p>(RUN light is on)</p>	<p>The indoor fan may stop to prevent re-evaporation of dehumidified moisture and to save energy.</p>
<p>Some steam escapes during COOL operation.</p>	<p>This may occur if the room's temperature and humidity are very high. It disappears as soon as the temperature and humidity decrease.</p>
<p>There is a slight smell.</p>	<p>Air blown out during operation may smell. This is caused by tobacco or cosmetics adhering to the unit.</p>
<p>You hear a slight gurgling sound.</p>	<p>This is caused by refrigerating liquid moving within the unit.</p>
<p>You hear a slight cracking sound.</p>	<p>This is caused by heat expansion or contraction.</p>
<p>You hear a hissing or clicking sound.</p>	<p>This is caused by the operation of the refrigerant control valves or electric components.</p>
<p>After a power cut, the unit does not restart even if power has been restored.</p>	<p>If the auto restart function is not set, the unit will not restart automatically. Use the remote control to start the operation again.</p>
<p>Remote control signals are not received.</p>	<p>Remote control signals may not be received if the signal receiver on the air-conditioner is exposed to direct sunlight or other bright light. If so, cut out the sunlight or reduce the other light.</p>
<p>Moisture may form on the air outlet grills.</p>	<p>If the unit is operated for a long time in high humidity, moisture may form on the air outlet grills and start dripping.</p>
<p>Whistling noise is heard from the outdoor unit.</p>	<p>The noise means that the revolution speed of the compressor is increasing or decreasing.</p>
<p>Fan will not stop immediately after unit operation was stopped.</p>	<p>Indoor fan : Fan will not stop after 2 hours if set to CLEAN operation. Outdoor fan : Fan will not stop about a 1 minute period in order to protect the unit.</p>
<p>RUN light stays on even though operation was stopped.</p>	<p>The RUN light illuminates during CLEAN operation. Run light turns off when CLEAN operation ends.</p>

Contact your dealer

- Turn off the power switch immediately and inform your dealer in any of the following situations:

The cable becomes extremely hot. The covering of the cable is cracked.		⚠ CAUTION
		If the power cord becomes damaged, ask your dealer or a qualified engineer to install the replacement to avoid accidents.
The fuse or switch blows continuously.	The TV, radio or other equipment starts to malfunction.	
A switch does not activate properly.	You hear a strange noise during operation.	
When abnormalities occur, turn off the power supply immediately and turn it on after 3 minutes. Restart the operation with ON/OFF button of the remote control and the abnormalities still continue.	The RUN and TIMER lights on the unit display section blink quickly (0.5 sec. ON; 0.5 sec. OFF) and do not work.	

Self diagnosis function

■ We are constantly trying to do better service to our customers by installing such judges that show abnormality of each function as follows:

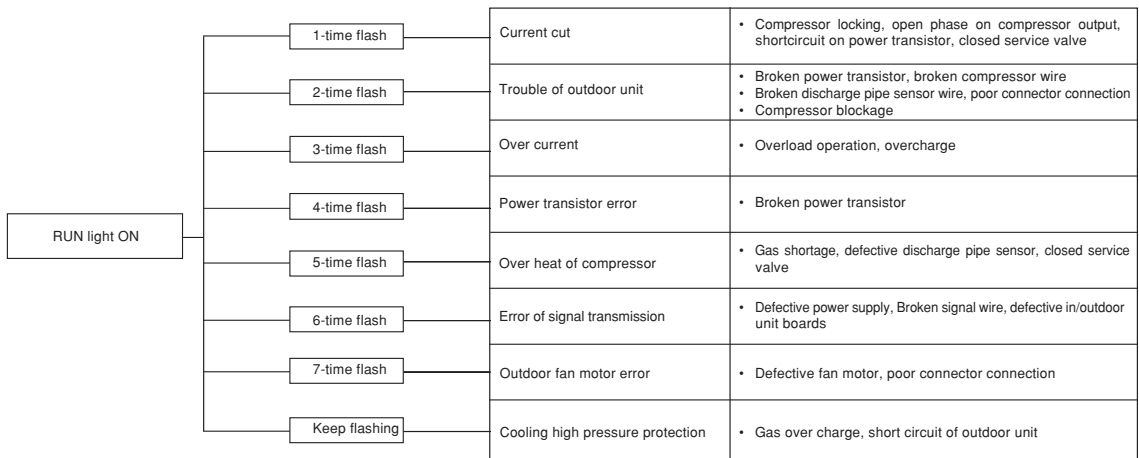
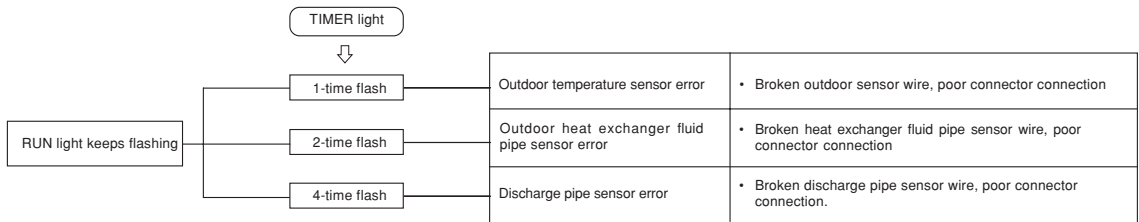
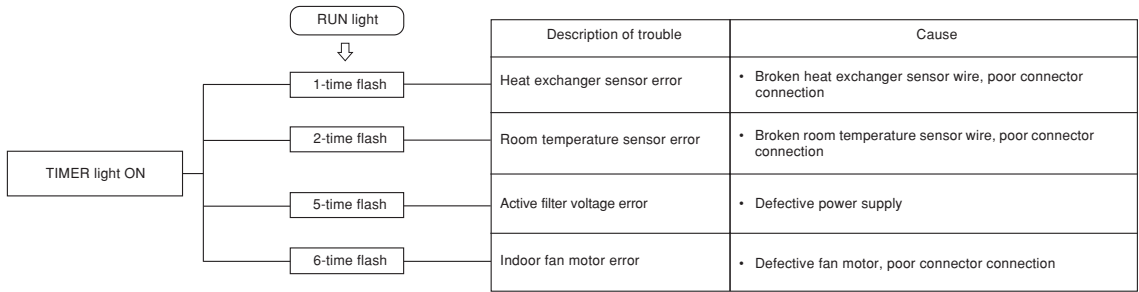



MITSUBISHI HEAVY INDUSTRIES, LTD.

AIR-CONDITIONING & REFRIGERATION DIVISION

3-1, Asahi, Nishibiwajima-cho, Kiyosu, Aichi, 452-8561, Japan
<http://www.mhi.co.jp>

MITSUBISHI HEAVY INDUSTRIES AIR-CONDITIONING EUROPE, LTD.

7 Roundwood Avenue, Stockley Park, Uxbridge, Middlesex, UB11 1AX, United Kingdom
Tel : +44-20-7025-2750
Fax: +44-20-7025-2751
<http://www.mhiae.com>

MITSUBISHI HEAVY INDUSTRIES AIR-CONDITIONERS AUSTRALIA, PTY. LTD.

9C Commercial Road Kingsgrove NSW 2208 PO BOX 318 Kingsgrove NSW 1480
Tel : +61-2-8571-7977
Fax: +61-2-8571-7992
<http://www.mhiae.com.au>